

HITACHI PROGRAMMABLE CONTROLLER

HIDIC EH-150

PROFIBUS-DP MASTER MODULE

APPLICATION MANUAL

WARNING

To ensure that the equipment described by this manual. As well as all equipment connected to and used with it, operate satisfactorily and safely, all applicable local and national codes that apply to installing and operating the equipment must be followed. Since codes can vary geographically and can change with time, it is the user's responsibility to determine which standard and codes apply, and to comply with them.

FAILURE TO COMPLY WITH APPLICABLE CODES AND STANDARDS CAN RESULT IN DAMAGE TO EQUIPMENT AND OR SERIOUS INJURY TO PERSONNEL.

INSTALL EMERGENCY POWER STOP SWITCH WHICH OPERATES INDEPENDENTLY OF THE PROGRAMMABLE CONTROLLER TO PROTECT THE EQUIPMENT AND OR PERSONNEL IN CASE OF THE CONTROLLER MALFUNCTION.

Personnel who are to install and operate the equipment should carefully study this manual and any others referred to by it prior to installation and / or operation of the equipment. Hitachi, Ltd. constantly strives to improve its products, and the equipment and the manual(s) that describe it may be different from those already in your possession.

If you have any questions regarding the installation and operation of the equipment, or if more information is desired, contact your local Authorized Distributor or Hitachi, Ltd.

IMPORTANT

THIS EQUIPMENT GENERATES, USES, AND CAN RADIATE RADIO FREQUENCY ENERGY AND, IF NOT INSTALLED AND USED IN ACCORDANCE WITH THE INSTRUCTION MANUAL, MAY CAUSE INTERFERENCE TO RADIO COMMUNICATIONS. AS TEMPORARILY PERMITTED BY REGULATION, IT HAS NOT BEEN TESTED FOR COMPLIANCE WITH THE LIMITS FOR CLASS A COMPUTING DEVICES PURSUANT TO SUBPART J OF PART 15 OF FCC RULES, WHICH ARE DESIGNED TO PROVIDE REASONABLE PROTECTION AGAINST SUCH INTERFERENCE.

OPERATION OF THIS EQUIPMENT IN A RESIDENTIAL AREA IS LIKELY TO CAUSE INTERFERENCE IN WHICH CASE THE USER, AT HIS OWN EXPENSE, WILL BE REQUIRED TO TAKE WHATEVER MEASURES MAY BE REQUIRED TO CORRECT THE INTERFERENCE.

LIMITED WARRANTY AND IMITATION OF LIABILITY

Hitachi, Ltd. (Hitachi) warrants to the original purchaser that the programmable controller (PLC) manufactured by Hitachi is free from defects in material and workmanship under normal use and service. The obligation of Hitachi under this warranty shall be limited to the repair or exchange of any part or parts which may prove defective under normal use and service within eighteen (18) months from the date of manufacture or twelve (12) months from the date of installation by the original purchaser which ever occurs first, such defect to be disclosed to the satisfaction of Hitachi after examination by Hitachi of the allegedly defective part or parts. This warranty is expressly in lieu of all other warranties expressed or implied including the warranties of merchantability and fitness for use and of all other obligations or liabilities and Hitachi neither assumes, nor authorizes any other person to assume for Hitachi, any other liability in connection with the sale of this PLC. This warranty shall not apply to this PLC or any part hereof which has been subject to accident, negligence, alteration, abuse, or misuse. Hitachi makes no warranty whatsoever in respect to accessories or parts not supplied by Hitachi. The term "original purchaser", as used in this warranty, shall be deemed to mean that person for whom the PLC is originally installed.

In no event, whether as a result of breach of contract, warranty, tort (including negligence) or otherwise, shall Hitachi or its suppliers be liable for any special, consequential, incidental or penal damages. Including, but not limited to, loss of profit or revenues, loss of use of the products or any associated equipment, damage to associated equipment, cost of capital, cost of substitute products, facilities, services or replacement power, down time costs, or claims of original purchaser's customers for such damages.

To obtain warranty service, return the product to your distributor, or send it with a description of the problem, proof of purchase, post paid, insured, and in a suitable package to:

Quality Assurance Dep.
Industrial Components & Equipment,
Production Operations Division,
Hitachi, Ltd.
46-1, Ooaza-Tomioka Nakajo-machi
Kitakanbara-gun, Niigata-ken
959-2608 JAPAN

Copyright 1999 by Hitachi, Ltd.
All Rights reserved - Printed in Japan

The information and/or drawings set forth in this document and all rights in and to inventions disclosed herein and patents which might be granted thereon disclosing or employing and the materials, techniques or apparatus described herein are the exclusive property of Hitachi, Ltd.

No copies of the information or drawings shall be made without the prior consent of Hitachi, Ltd.

Hitachi, Ltd. provides customer assistance in varied technical areas. Since Hitachi does not possess full access to data concerning all of the uses and applications of customer's products, responsibility is assumed by Hitachi neither for customer product design nor for any infringements of patents or rights of others which may result from Hitachi assistance.

The specifications and descriptions contained in this manual were accurate at the time they were approved for printing. Since Hitachi, Ltd. Incorporated constantly strives to improve all its products, we reserve the right to make changes to equipment and manuals at any time without notice and without incurring any obligation other than as noted in this manual.

Hitachi, Ltd. assumes no responsibility for errors that may appear in this manual.

As the product works with user program and Hitachi, Ltd. cannot test all combination of user program components, it is assumed that a bug or bugs may happen unintentionally. If it is happened: please inform the fact to Hitachi, Ltd. or its representative. Hitachi will try to find the reason as much as possible and inform the countermeasure when obtained.

Nevertheless Hitachi, Ltd. intends to make products with enough reliability, the product has possibility to be damaged at any time. Therefore personnel who are to install and operate the equipment has to prepare with the counter-measure such as power off switch can be operated independently of the controller. Otherwise, it can result in damage to equipment and/or serious injury to personnel.

Safety Precautions

Read this manual and related documents thoroughly before installing, operating, performing preventive maintenance or performing inspection, and be sure to use the unit correctly. Use this product after acquiring adequate knowledge of the unit, all safety information, and all cautionary information. Also, make sure this manual enters the possession of the chief person in charge of safety maintenance.

Safety caution items are classified as "Danger" and "Caution" in this document.



: Cases where if handled incorrectly a dangerous circumstance may be created, resulting in possible death or severe injury.



: Cases where if handled incorrectly a dangerous circumstance may be created, resulting in possible minor to medium injury to the body, or only mechanical damage.

However, depending on the circumstances, items marked with



may result in major accidents.

In any case, they both contain important information, so please follow them closely.

Icons for prohibited items and required items are shown below:



: Indicates prohibited items (items that may not be performed). For example, when open flames are prohibited,  is shown.



: Indicates required items (items that must be performed). For example, when grounding must be performed,  is shown.

1. About installation

CAUTION

- Use this product in an environment as described in the catalogue and this document.
If this product is used in an environment subject to high temperature, high humidity, excessive dust, corrosive gases, vibration or shock, it may result in electric shock, fire or malfunction.
- Perform installation according to this manual.
If installation is not performed adequately, it may result in dropping, malfunction or an operational error in the unit.
- Do not allow foreign objects such as wire chips to enter the unit.
They may become the cause of fire, malfunction or failure.

2. About wiring

REQUIRED

- Always perform grounding (FE terminal).
If grounding is not performed, there is a risk of electric shocks and malfunctions.

CAUTION

- Connect power supply that meets rating.
If a power supply that does not meet rating is connected, fire may be caused.
- The wiring operation should be performed by a qualified personnel.
If wiring is performed incorrectly, it may result in fire, damage, or electric shock.

3. Precautions when using the unit

DANGER

- Do not touch the terminals while the power is on.
There is risk of electric shock.
- Structure the emergency stop circuit, interlock circuit, etc. outside the programmable controller (hereinafter referred to as PC).
Damage to the equipment or accidents may occur due to failure of the PC.
However, do not interlock the unit to external load via relay drive power supply of the relay output module.

CAUTION

- When performing program change, forced output, RUN, STOP, etc., while the unit is running, be sure to verify safety.
Damage to the equipment or accidents may occur due to operation error.
- Supply power according to the power-up order.
Damage to the equipment or accidents may occur due to malfunctions.

4. About preventive maintenance

DANGER

- Do not connect the \oplus , \ominus of the battery in reverse. Also, do not charge, disassemble, heat, place in fire, or short circuit the battery.
There is a risk of explosion or fire.

PROHIBITED

- Do not disassemble or modify the unit.
These actions may result in fire or malfunction.

CAUTION

- Turn off the power supply before removing or attaching module/unit.
Electric shock, malfunction or failure may result.

Table of contents

Chapter 1	INTRODUCTION	1-1
	1.1 Before Use	1- 1
	1.2 Technical features	1- 1
Chapter 2	STRUCTURE and SPECIFICATION	2-1 to 2-2
	2.1 Structure and Parts name	2- 1
	2.2 Specification	2- 2
Chapter 3	CONFIGURATIONS	3-1 to 3-7
	3.1 System configurations	3- 1
	3.2 Start up	3- 2
Chapter 4	Installation and Wiring	4-1 to 4-4
	4.1 Installation of Module.....	4- 1
	4.2 Loading the Module.....	4- 1
	4.3 Wiring.....	4- 2
Chapter 5	Normal Operation	5-1
	5.1 Start-up Sequence	5- 1
	5.2 Data exchange	5- 1
	5.3 Data format	5- 1
Chapter 6	Indications	6-1 to 6-8
	6.1 LED Indications.....	6- 1
	6.2 Link Information Flag Area.....	6- 4
Chapter 7	Daily and Periodic Inspection	7-1
Chapter 8	Troubleshooting	8-1

Chapter 1 INTRODUCTION

We appreciate that you have selected the EH-150 Profibus Master Module of the Hitachi programmable logic controller. This application manual describes how to properly operate the EH-150 Profibus Module. Carefully read the manual to familiarize yourself with the procedures respectively of installation , operation, and maintenance and check.

reference documents

(1) EH-150 APLICATION MANUAL ----- NJI-281*(X)

*The last character of the manual number may be modified when the product is revised.

Notes. The contents of this manual may be modified without previous notice.

1.1 Before Use

When you purchased the EH-150 Profibus Master Module , please check the following matters:

- (1) If model name and specifications are correct.
- (2) If there is no shipping damage on product (If any, consult the dealer of this module.)
- (3) If following parts are in a carton box.

table 1.1 List of Counter Module Parts

NO.	Contents	Quantity	Remark
1	EH-150 Pofibus Master Module	1	
2	Protection sheet	1	For the cover of DIP-SW Attaching to the case
3	Notes to use	1	

1.2 Technical features

- **Class 1 Profibus-DP master**
- **All baud rates from 9.6kbps up to 12Mbps**
- **Can be used with EH-150 CPU (EH-CPU308/316) ROM version 00 (software version 2.08) and later.**
- **Up to 124 slaves**
- **256 words input data and 256 words output data**
- **Fieldbus connector: 9 pin D-sub , female**
- **Uses the LINK area in the EH-150 CPU.**

Chapter 2 STRUCTURE and SPECIFICATION

2.1 Structure and Parts name

Name and function		Model		EH-RMP	
		Weight		Approx. 130g	
		Current		Approx. 600mA	
		dimension (mm)			
No	Name	Function		Remarks	
1)	Lock button	This is used when removing the module from the base unit. After it is installed to the base unit, the fixation can be reinforced using screws. In this case, use M4x10 mm screws.			
2)	LEDs	STATUS: the state of the EH-RMP RUN: communication running ERR: error on communication line RDY: device has no error TOKEN: lit all the time			
3)	Connector 1	Connect to PC(configurator)		9pin male D-sub Be careful, this connector become hot.	
4)	Reset switch	When module is abnormal, module is be reset by pushing this.			
5)	DIP switch ^{*1} (No. 1,2 not used)	Switch No.		Supplementary explanation	
		4	3	(when the CPU is stopped)	
		OFF	OFF	CLEAR mode: the output data is cleared.	
		OFF	ON	FREEZE mode: the output data is frozen.	
		ON	OFF	COPY mode: the output data is copied from the CPU.	
ON	ON	Not use			
6)	Termination switch	ON: bus termination enabled OFF: bus termination disabled			
7)	Connector 2	Connect to field bus		9pin female D-sub The screw is the terminal for functional earth.	

Note1: For setting of this switch, remove the module from the rack.

If the setting ends, cover with the protection sheet.

2.2 Specification

ITEM	Specification	
General	Power source	Supplied from power Supply Module
	Operating ambient temperature	0 to 55 degree
	Storage ambient temperature	-10 to 75 degree
	Operating ambient humidity	No condensation 20 to 90 % RH
	Storage ambient humidity	No condensation 10 to 90 % RH
	Vibration resistance	In accordance with JIS C 0911
	Noise resistance	○Noise voltage 1500 Vpp Noise pulse with 100 ns, 1μs by using noise simulator. ○Based on NEMA ICS 3-304 (with the exception of input module) ○Static noise : 3000 V at metal exposed area
	Dielectric withstand voltage	250 V DC between External signal terminal and FE terminal
	Consumption current	5 V DC 600 mA
	Usage environment	No corrosive gasses, no excessive dirt
	Structure	Attaches to an open wall
	Cooling	Natural air cooling
	Function	Number of modules
Number of slaves		Up to 124 slaves
Output data		256 words
Input data		256 words
I/O assignment		LINK ¹⁾
Data transfer rate :		9.6 kbps : 1200 m
Max segment length		19.2 kbps : 1200 m
		45.45 kbps : 1200 m
		93.75 kbps : 1200 m
		187.5 kbps : 1000 m
	500 kbps : 400 m	
	1500 kbps : 200 m	
	3 Mbps : 100 m	
	6 Mbps : 100 m	
	12 Mbps : 100 m	
Self-diagnosis	System ROM/RAM check, watch-dog timer check	
GSD file	File name : Hms_1004.gsd This file can either be downloaded from the webpage http://www.hms.se/fbfiles.htm or received by contacting HMS Fieldbus AB .	
Configurator	Please buy the configurator from HMS Fieldbus AB . Order number: KONF-PDP	

1) LINK area(1024 word) is used. Can not use for internal I/O.

Chapter 3 CONFIGURATIONS

3.1 System configurations

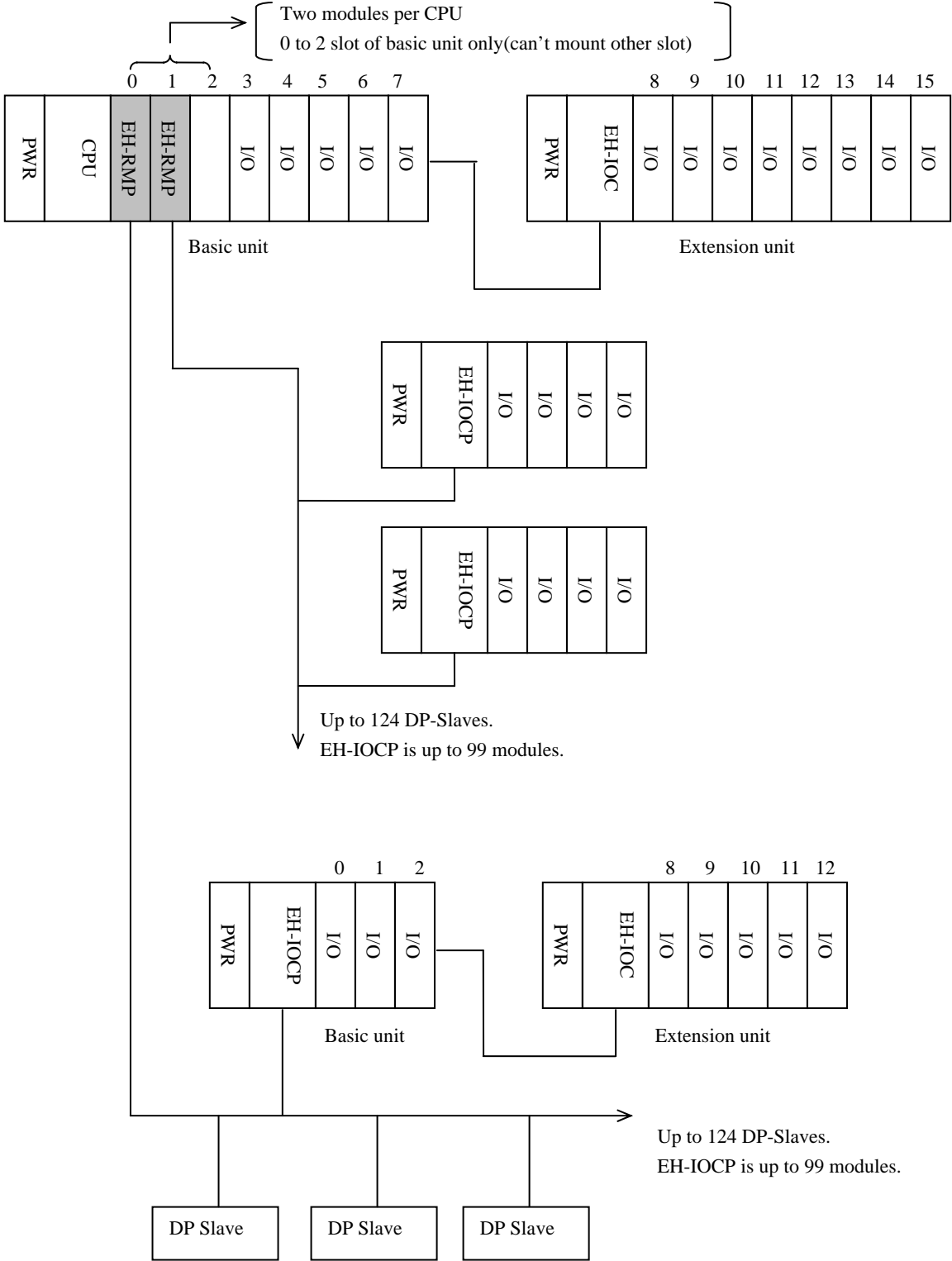

Fig. 3.1 Example of system configurations

3.2 Start up

To operation this module normally, the making a setup which is shown in the following figure is necessary.

- (1) Set the DIP switch. Refer to chapter 3.2.1 .
- (2) Set the termination switch.
. Refer to chapter 3.2.2 .
- (3) Set the configuration data from the configuration tool.
. Refer to chapter 3.2.3 .
- (4) Set the LINK parameter data from the Ladder editor.
. Refer to chapter 3.2.4 .

3.2.1 DIP switch

The EH-RMP can be configured to run in different modes depending on the users requirements.

The configuration is accomplished by the switch placed on the right side of the EH-RMP.

Note 1: The configurations will affect the behavior of the output area when the CPU is turned from RUN to STOP.
The behavior of the input area are the same in all modes, the entire input area are always copied.
Note 2: Don't operate this switch while EH-RMP is working.

(1) Clear mode

When the CPU is switched from RUN to STOP position, the EH-RMP outputs the zero data to Profibus.

But the link output area(WL) is not cleared.

Switch	Position
1	Don't care
2	Don't care
3	OFF(default)
4	OFF(default)

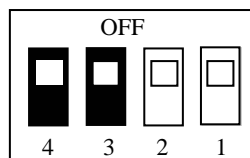

(2) Freeze mode

When the CPU is switched from RUN to STOP position, the EH-RMP freezes the output data with the value present when the switch is performed.

The "SET RESET" and the "FORCED OUT" function from the programming tool for EH-150 PLC are invalid.

Switch	Position
1	Don't care
2	Don't care
3	ON
4	OFF

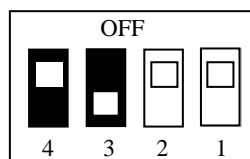

(3) Copy mode

When the CPU is switched from RUN to STOP position, the EH-RMP continues to copy the data present in the link output data. This mode is effective when using the EH-150 CPU(EH-CPU308/316) ROM version 02 (software version 2.12) and later.

Switch	Position
1	Don't care
2	Don't care
3	OFF
4	ON

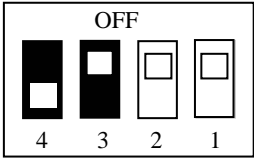

EH-CPU 308/316 ROM ver. 02
 The clear mode / the freeze mode for LINK area can be set from user.

3.2.2 Termination switch

The start node and the end node in a Profibus-DP network has to be terminated to avoid reflections on the bus line. The EH-RMP is equipped with a termination switch to accomplish this in an easy way.

If the module is used as the first or last module in a network the termination switch has to be in ON position.

Otherwise the switch has to be in OFF position.

Termination switch	Bus termination
ON	ENABLED If the module is the last or first module, the bus termination has to be set on, or an external termination connector has to be used.
OFF	DISABLED

3.2.3 Configuration from configurator

The configuration of the EH-RMP is accomplished by the configurator called SyConDP.

For general information about the configurator, please refer to the manual for this configurator.

(1) The entry of the EH-RMP

Click the Master icon , and click left-top corner on “Device” area.

Select the “Profibus-DP Master”, and set the station address.

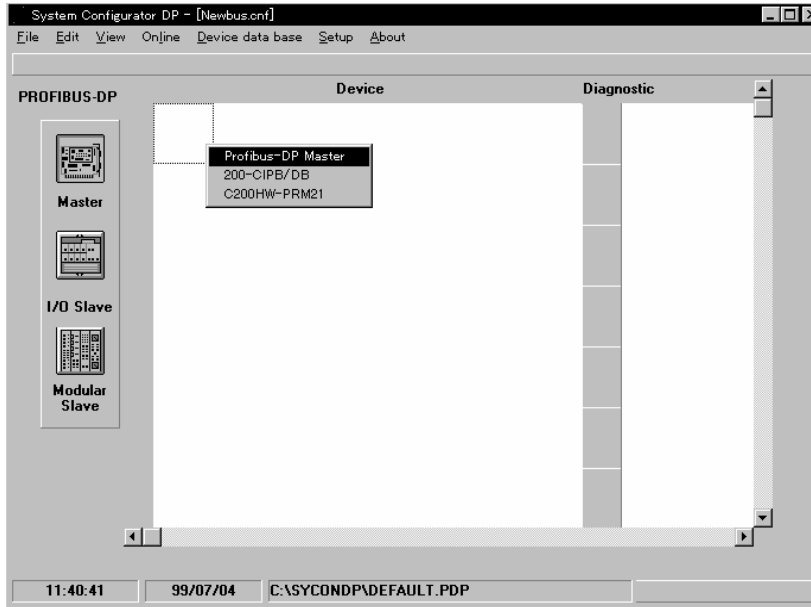

Fig. 3.2 Select Master device

(2) The entry of the slave device

Click the I/O Slave or Module Slave icon, and click left side on “Device” area.

Select a slave device, and set the station address.

Following figure is the example of selected the EH-IOCP of Modular Slave.

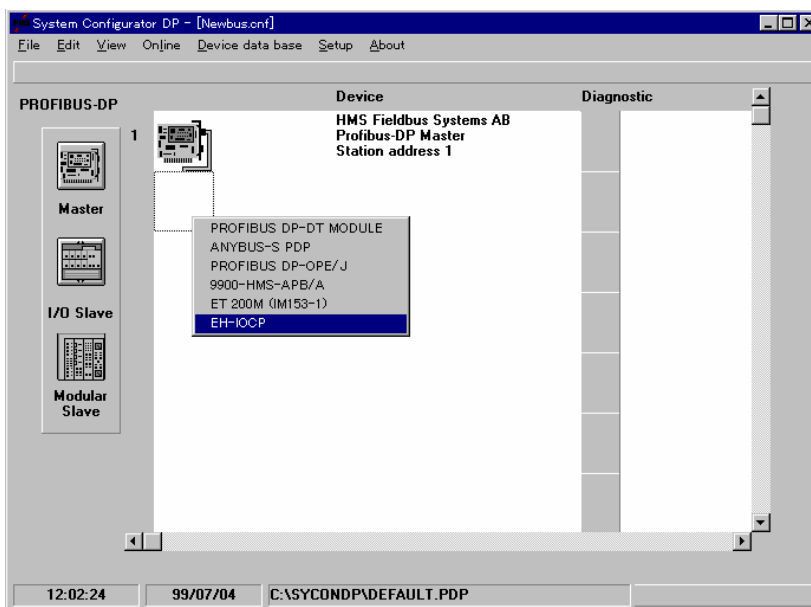

Fig. 3.3 Select Slave device

(3) Make configuration and parameter data

Double click on the selected device.

And make the configuration data and parameter data.

In the configuration data is set the byte offset address from start address of output link area or input link area.

For the details of the configuration data and the parameter data to the slave equipment, please refer to the manual of each slave equipment.

Fig. 3.4 and Fig. 3.5 is the example for EH-IOCP.

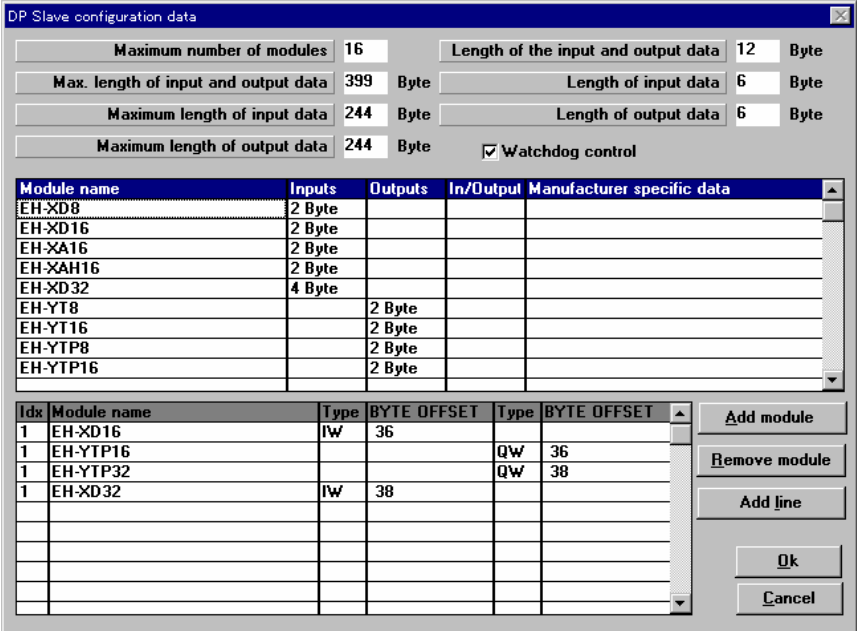

Fig. 3.4 Configuration data for EH-IOCP

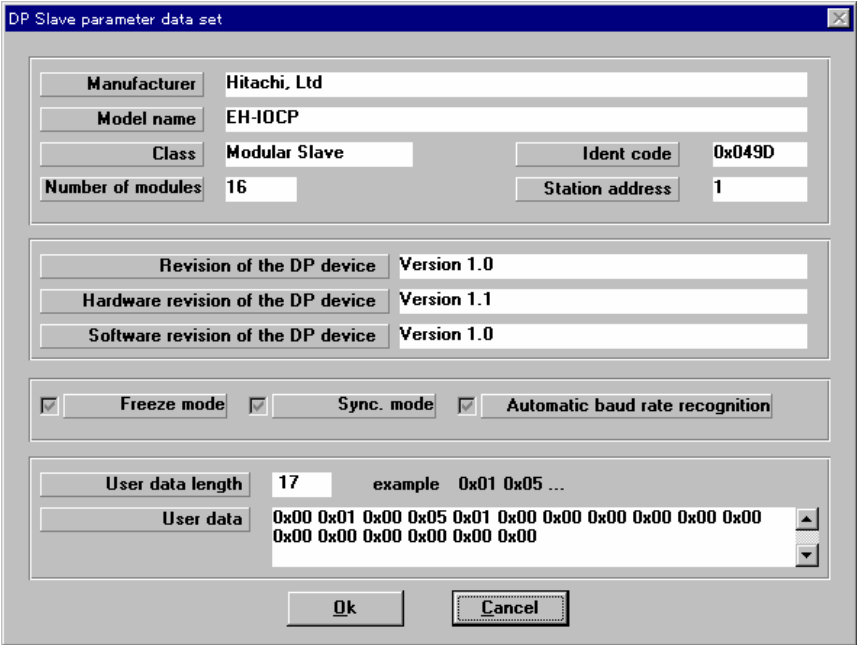

Fig. 3.5 Parameter data for EH-IOCP

(4) Set the bus parameter

In the menu Set-up/Bus parameter the window shows the actual bus parameters.

Changing the baud rate has the consequence, that all other parameters will be re-calculated,

The Highest Station Address is the highest bus address up to which the master will search for other master.

This should not be set below the master address.

Auto_Clear Mode ON, the DP Master leaves the user data transfer and switches the outputs of all assigned DP-slaves to the fail-safe state.

Parameter	Value	Unit
Baud rate	12000	kBits/s
Slot Time	1000	t_bit
Min. Station Delay Responder	11	t_bit
Max. Station Delay Responder	800	t_bit
Quiet Time	9	t_bit
Setup Time	16	t_bit
GAP Actualization Factor	10	
Max Retry Limit	4	
Highest Station Address	126	
Poll Timeout	1	ms
Target Rotation Time (1)	10558	t_bit
Target Rotation Time (2)	0.880	ms
Watchdog Control Time	100	ms
Data Control Time	700	ms
Min Slave Interval	0.100	ms

Bp Flag

Auto_Clear Mode OFF

Auto_Clear Mode ON

Buttons: Ok, Cancel

Fig. 3.6 Bus parameter

3.2.3 Configuration from Ladder Editor

The EH-150 CPU has two link areas of 1024 words (No.1 LINK and No.2 LINK).
 The EH-RMP operates in the EH-150 system as a LINK module. The first EH-RMP in a rack uses No.1 LINK area and the second EH-RMP uses No.2 LINK area .
 For the EH-RMP, specify the output area size of the link (maximum 256 words).
 Top Assign No. is fixed to WL0. (for No.2 LINK is WL1000.)
 Last Assign No. is between WL0 and WLFF. (for No.2 LINK is between WL1000 and WL10FF.)
 Input area of the link is always fixed from WL200 to WL2FF (for No.2 LINK is WL1200-WL12FF).

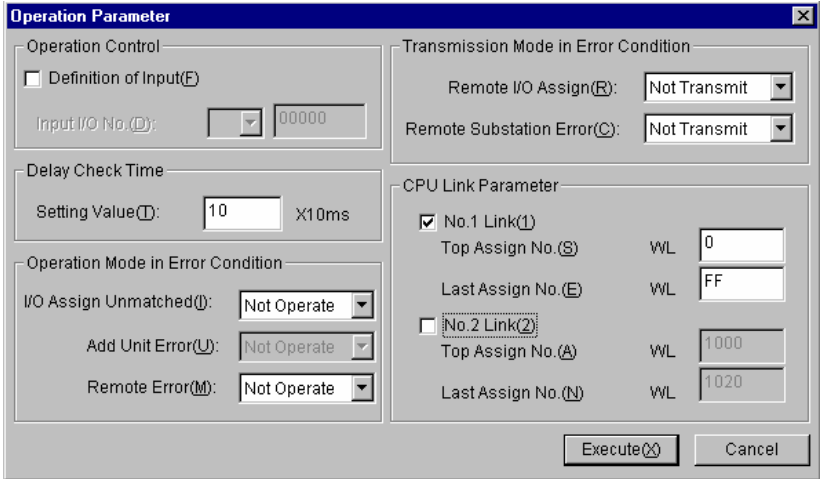

Fig. 3.7 LINK Parameter

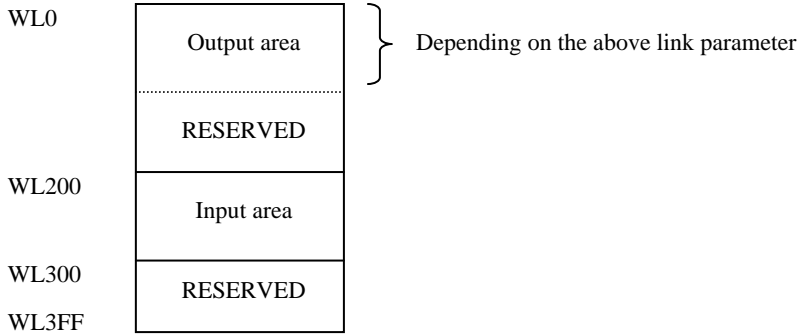

Fig. 3.8 LINK area 1 mapping

NOTE1:
 All address in the link area are word addresses.
 All address in the configurator(SyCON DP) are byte addresses.

NOTE2:
 The EH-150 CPU uses 1024 words for the EH-RMP.
 But the effective data area is 256 words of input data and 256 words of output data.
 512 words of the remainder are reserved.

Chapter 4 Installation and Wiring

4.1 Installation of Module

EH-RMP can be installed in 0-2 slot on the basic base unit.
Install and uninstall the module after turn off the base unit power source.

4.2 Loading the Module

(1) Installing

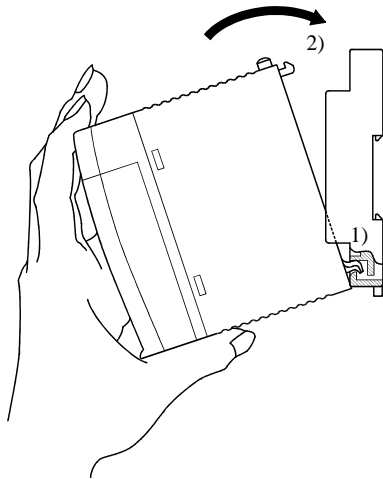

- 1) Hook the claw at the lower section of the module to the hole in the base.
- 2) Press in the upper side of the module until it clicks.

Note 1: After loading the module, check to make sure it does not come out.

Note 2: Load the power module at the leftmost side of the base unit.

Note 3: Load the CPU module and I/O controller to the right neighbor of the power module.

(2) Removing

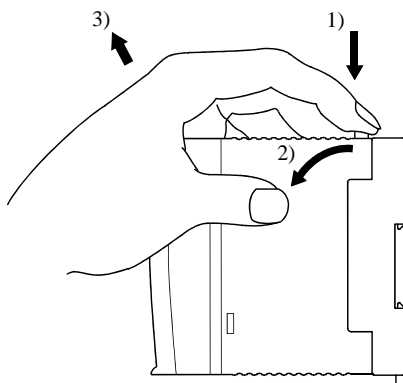

- 1) Push in the lock button.
- 2) With the lock button pushed in, pull the top of the module toward the front.
- 3) Raise it toward the top and pull it out.

Note: For the power module, pull it out while pushing down the two lock buttons.

4.3 Wiring

For information about installation of the Profibus DP fieldbus, please refer to the document :
Installation Guideline for PROFIBUS-DP/FMS from PNO, Order No. 2.112.

Profibus homepage on the Internet: <http://www.profibus.com>

4.3.1 Profibus port

EH-RMP has D-sub 9 pin female connector for Profibus port.
Use the connector which suits EH-RMP.

Example of a suitable D-sub connector : Siemens, Order number : 6GK1500-0EA02

Table 4.1 Pin order of Profibus port

Pin number	Description
1	Shield
2	Not connected
3	B-Line
4	RTS (TTL)
5	GND Bus
6	+5V Bus
7	Not connected
8	A-Line
9	Not connected

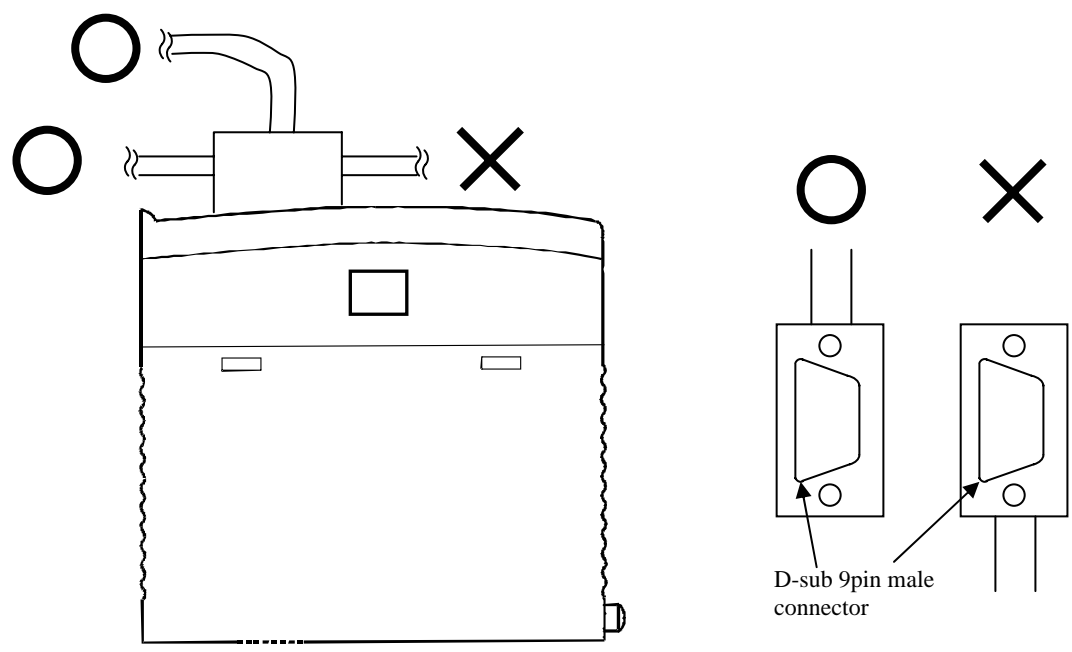

Fig. 4.1 The connector type for the EH-RMP

4.3.2 Cable parameters

The bus cable is specified in EN 50170 part 8-2 as "Cable Type A", and should comply with the parameters in the table below.

Cable Type B, which is also described in EN 50170, is outdated and should no longer be used.

Example of cable for Profibus DP: Siemens, Order number: 6XV1830-0EH10

Table 4.2 Cable parameters

Parameter	Cable type A
Characteristic impedance	135 to 165 Ω at a frequency of 3 to 20 MHz
Operating capacity	< 30 pF/m
Loop resistance	<= 110 Ω /km
Core diameter	> 0.64 mm *)
Core cross-section	> 0.34 mm ² *)

*) The cable cross-sections used should be compatible with the mechanical specifications of the bus interface connector.

4.3.3 Maximum length of bus segment

The cable parameters specified for standard Type A bus cables result in the maximum length of each bus segment for the respective data transfer rate shown in table 4.3 .

Table 4.3 Maximum cable lengths per segment

Data transfer rate (kbit/s)	9.6	19.2	93.75	187.5	500	1500	3000	6000	12000
Max. segment length (m)	1200	1200	1200	1000	400	200	100	100	100

<Notes of wiring>

1) Add a ferrite core

Insert a ferrite core with the bus cable.

Insert a ferrite core with the input/output shielded wires, and wind the shielded wires by one turn around the ferrite core.

2) To guarantee correct operation, connect to Functional Earth from screw of D-sub female connector.

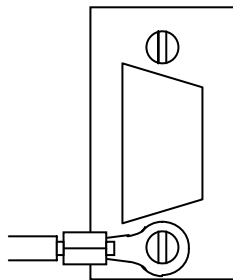

Fig. 4.2 Functional Earth

4.3.4 Configuration port

EH-RMP has D-sub 9 pin male connector for configuration port.
The configuration port on EH-RMP is connected to a PC COM port via an ordinary null modem cable.

Table 4.4 Pin order of configuration port

Pin number	Signal	Description
1	NC	Not connected
2	RxD	Receive Data
3	TxD	Transmit Data
4	DTR	Data Terminal Ready
5	GND	Ground
6	NC	Not connected
7	RTS	Request To Send
8	CTS	Clear To Send
9	NC	Not connected

Chapter 5 Normal Operation

5.1 Start-up Sequence

When the power is turned on the EH-RMP will perform an internal hardware check.

The STATUS LED will flash Green -> Red -> Green -> Red and then start flashing green with 1Hz until the initialization sequence is finished, then the STATUS LED should be constantly lit green.

If the STATUS LED continues to flash with 1Hz and nothing happens, the reason might be that the slot is not configured for a link module in the EH-150 CPU.

5.2 Data exchange

When the initialization sequence is finished the data exchange with the slave starts automatically.

When the CPU is in RUN mode both the input data and the output data will be copied.

When the CPU is in STOP mode, the input data are copied in the same way as during RUN mode, but the output data behaves according to the setting of the configuration switch.

5.3 Data format

The data format which the EH-RMP outputs at the Profibus-DP is below.

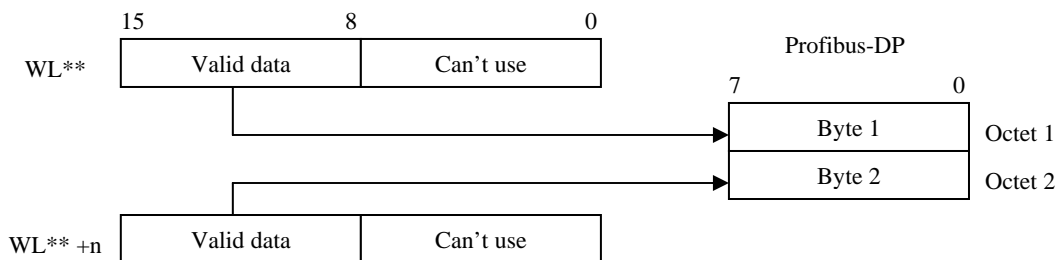

Fig. 5.1 1 Byte data format for byte oriented slave module

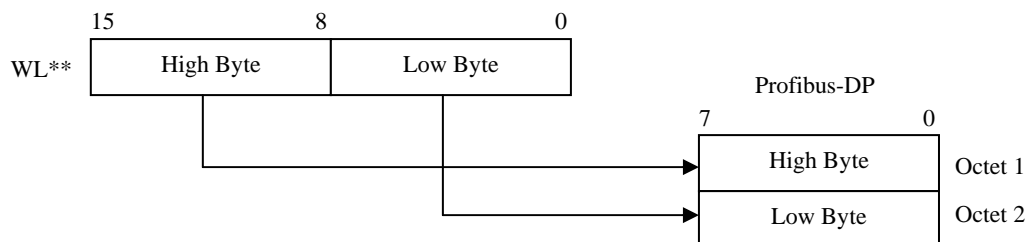

Fig. 5.2 Word data format



As for the output data on slave, high byte and low byte for word data (or high word and low word for long word data) are swapped, it is dependent on slave type.
The factor is Word / Byte oriented, Motorola / Intel format.
In this case, make the user program after confirming the output format of the data on the slave.

Chapter 6 Indications

The EH-RMP can give indications to the user in two different ways. The first way is via the five indications LED at the top of the module and the second way is via the special internal output of EH-150 CPU, where detailed information about the Profibus DP network is available for the PLC programmer.

6.1 LED Indications

The LED Indications are placed at the top of this module.



6.1.1 Status LED (STATUS)

The status LED will give information about the state of the EH-RMP.

The LED will flash red or green different times depending on the status indicated.

The status LED will flash green if the error is recoverable (the error can be recovered without a restart of the module) and red if the error is non-recoverable (the error can not be recovered without a restart of the module or the module needs to be replaced).

6.1.1.1 Normal operation

When the EH-RMP is initialized and has entered the normal operation state, the status LED is constantly lit green.

This indication also indicates that there are no errors reported from the EH-RMP.

Color: Green

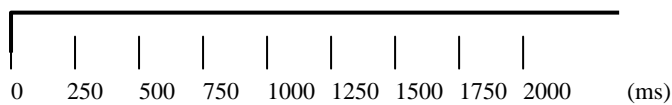

6.1.1.2 Initialization

During the initialization sequence, the status LED will flash green with 1Hz according to the pattern below.

Color: Green

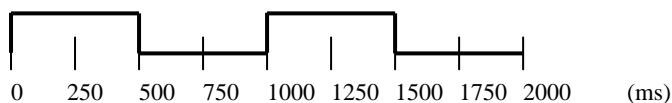

6.1.1.3 EH-RMP locked

If the EH-RMP is locked for some reason, the status LED is lit constantly red.

6.1.1.4 Recoverable errors

The status LED will flash green if the error is recoverable. The flashing sequence are built up according to the figures below.

Color: Green

Two flashed:

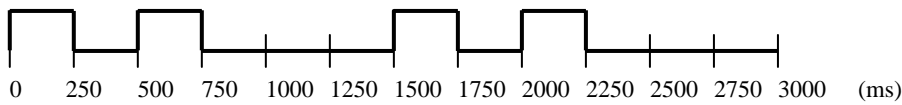

Color: Green

Three flashed:

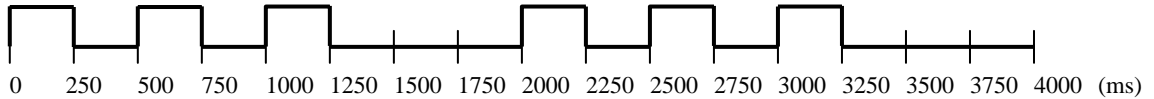

Color: Green

Four flashes:

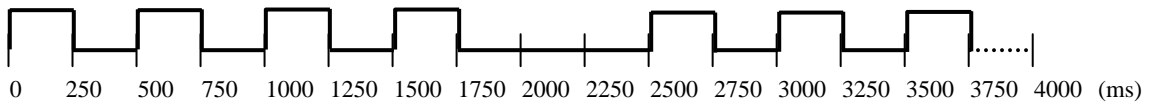

Color: Green

Four flashes:

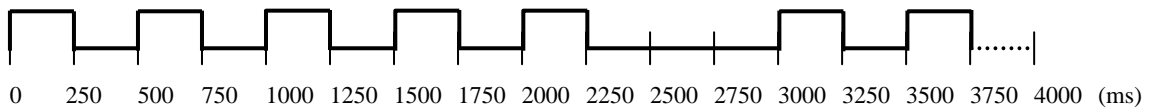

Table 6.1 Recoverable errors

Number of flashes	Fault	Cause	Action
2	PLC fault	If the PLC indicates a fault, the EH-RMP will stop the data exchange and indicate this by flashing the status LED two times.	Check the PLC for cause of the error.
3	Database download or Database not present	When a database is downloaded to the EH-RMP, or if there is no database present in the EH-RMP, the status LED will flash three times according to the pattern below.	<i>Database downloading:</i> Wait for the database downloaded to flash. <i>No database present:</i> Download database
4	Link length out of range	If the LINK length configured from the PLC is less than 1 or larger than 256 words or if the link start address is not equal to zero, the status LED will flash green four times. The data exchange will not start.	Check the link length and the link start address in the PLC programming tool.
5	Profibus DP master fault	If the EH-RMP reports an error during data exchange, the status LED will flash green five times.	For information about the fault, please check the 'Error number register', and the 'Device Error register' in the link information flag area.

6.1.1.5 Non-Recoverable errors

The status LED will flash red if the error is non-recoverable. The flashing sequence are built up according to the same pattern as for the recoverable errors.

Table 6.2 Non-recoverable errors

Number of flashes	Fault	Cause	Action
1	RAM fault	The RAM check on the EH-RMP carrier board failed.	Contact supplier
2	FLASH fault	The CRC check on the EH-RMP carrier board failed.	Contact supplier
3	ASIC fault	The ASIC check on the EH-RMP carrier board failed.	Contact supplier
4	Wrong master	Wrong master module is mounted on the carrier board.	Contact supplier
5	Initialization error	An error is reported during the initialization of the Profibus DP master.	Check the 'Error number register', the 'Error remote address register' and the 'Device Error register' in the link information flag area.

6.1.2 Run LED (RUN)

Color: Green

Table 6.3 Run LED indications

Indication	Description
Cyclically flashing 4Hz (50% on, 50% off)	Master is ready to start communication
Random flashing	Configuration error or fatal error
Constantly lit	Communication running

6.1.3 Ready LED (RDY)

Color: Green

Table 6.4 RDY LED indications

Indication	Description
Cyclically flashing 4Hz (50% on, 50% off)	Hardware or system error or firmware / configuration database download in progress.
Cyclically flashing 1Hz (50% on, 50% off)	Flash only contains bootloader, no valid firmware stored in flash.
Constantly lit	Module is OK. ("Device error = 0")

6.1.4 Error LED (ERR)

Color: Red

Table 6.5 ERR LED indications

Indication	Description
Constantly lit red	Error on communication line. If a slave that is configured in the master is not connected to the fieldbus, this led is lit.
Turned off	No error

6.1.5 Token LED (TOKEN)

Color: Green

Table 6.6 TOKEN LED indications

Indication	Description
Constantly lit	The master has the token in a multi-master system. If only one master is used, this LED is lit all the time.
Turned off	The master does not have the token.

Note: The EH-RMP supports a mono-master system. This LED is lit constantly.

6.2 Link Information Flag Area

In the Link information flag area, the LADDER EDITOR can get valuable information about the Profibus DP fieldbus. The data is represented in Motorola format in the EH-150 CPU.

OFFSET address(word)
Start address of LINK No.1 : WRF0E0
Start address of LINK No.2 : WRF140

Table 6.7 Contents in the LINK information flag area

15	14	13	12	11	10	9	8	7	6	5	4	3	2	1	0	
Reserved								Error Code								+00
Reserved								Reserved								+01
Reserved								Reserved								+02
Reserved								Reserved								+03
Main state of master system								Global error bits								+04
Error number								Error remote address								+05
Heavy bus error count																+06
Number of rejected Profibus telegrams																+07
Reserved																+08
Reserved																+09
Reserved																+0A
Reserved																+0B
15															0	+0C
31															16	+0D
47															32	+0E
63							Slave Config								48	+0F
79															64	+10
95															80	+11
111	126														96	+12
-		125	124	123											112	+13
15															0	+14
31															16	+15
47															32	+16
63							Slave State								48	+17
79															64	+18
95															80	+19
111	126														96	+1A
-		125	124	123											112	+1B
Reserved																+1C
Reserved																+1D
Reserved																+1E
Reserved																+1F
Reserved																+20
Reserved																+21
Reserved																+22
Reserved																+23
Reserved																+24
Reserved																+25
Reserved																+26
Device Error								Reserved								+27
Reserved																
Refreshing time max (ms)																+5D
Refreshing time min (ms)																+5E
Refreshing time now (ms)																+5F

6.2.1 Error Code

Table 6.8 Error code

Link module	Link address	Notes
Link No. 1	WRF0E0	Low byte (High byte not used)
Link No. 2	WRF140	Low byte (High byte not used)

The following error codes can be present in this register:

hex00 No error

hex01 Failed to initialize Profibus DP master.

hex02 Start Address of link area in the PLC is not zero.

hex03 The link length configured in the PLC equals zero or is larger than 256 words.

hex06 Internal Error on Profibus DP master.

6.2.2 Main state of master system

Table 6.9 Main state of master system

Link module	Link address	Notes
Link No. 1	WRF0E4	High byte
Link No. 2	WRF144	High byte

This register contains information about the state of the master system. The following states can be present.

hex00 Off-line

hex40 Stopped

hex80 Clear

hexC0 Operate

6.2.3 Global error bits

Table 6.10 Global error bits

Link module	Link address	Notes
Link No. 1	WRF0E4	low byte
Link No. 2	WRF144	low byte

The following errors can be present:

Table 6.11 Detail of Global error bits

Bit number	Name	Description
7-6		Reserved
5		1= HOST is not ready 0= normal operation
4		1= Bus short circuits detected 0= Normal operation
3		1= Because of heavy bus error, no further bus communication is possible 0= Normal Operation
2	No data	1 = At least one remote node is not in the data exchange mode or reports fatal error 0 = Normal Operation
1	Auto clear	1 = The master branched into auto clear mode because of a remote node error 0 = Normal Operation
0	Control	1 = A parameter error occurred 0 = Normal Operation

6.2.4 Error number

Table 6.12 Error number

Link module	Link address	Notes
Link No. 1	WRFOE5	High byte
Link No. 2	WRF145	High byte

This register can contain two types of errors, Internal errors and External errors, depending on the value of the register 'Error remote address'. If 'Error remote address' is equal to 0xFF this register reports an Internal error otherwise this register reports an External error.

6.2.4.1 External errors

Table 6.13 External errors

Value	Description	Error source	Action
hex00	Remote node OK	-	-
hex03	Function in remote node is not activated.	Remote node	Check if remote node is Profibus DP norm conform or the correct GSD files are used.
hex09	No answer data	Remote node	Check bus cable
hex11	No response of the slave	Remote node	Check bus cable and bus address of the remote node.
hex12	The master is not into the logical token ring.	Master	Check FDL/node address of master or highest station address of other master systems.

6.2.4.2 Internal errors

Table 6.14 Internal errors

Value	Description	Error source	Action
hex00	No error	-	-
hex32-hex35	Internal error	Master	Contact supplier
hex36	No database present	Master	Download database
hex37	Faulty parameter value in the master parameter.	Project planning	Contact supplier
hex38	No remote node parameter	Project planning	Download database
hex39	Faulty parameter value in the remote node parameter.	Project planning	Contact supplier
hex3A	Double remote node address	Project planning	Check remote node addresses.
hex3B	Projected send process data offset address of a node is outside the allowable border.	Project planning	Check projected send offset addresses.
hex3C	Projected receive process data offset address of a node outside the allowable border.	Project planning	Check projected receive offset addresses.
hex3D	Data areas of remote nodes are overlapping in the receive process area.	Project planning	Check projected receive offset addresses.
hex3E	Data areas of remote nodes are overlapping in the send process area.	Project planning	Check projected send offset addresses.
HexCA	No segment free	Master	Contact supplier
hexD4	Faulty reading of configuration data	Master	Download database
hexD5	System fault	Master	Contact supplier
Others	Not allowed	-	Contact supplier

6.2.5 Error remote address

Table 6.15 Error remote address

Link module	Link address	Notes
Link No. 1	WRF0E5	Low byte
Link No. 2	WRF145	Low byte

If this register is equal to 0xFF, an internal master error, otherwise this register indicates the node number of a faulty node. The error code is specified in the 'Error number' register.

6.2.6 Heavy bus error count

Table 6.16 Heavy bus error count

Link module	Link address	Notes
Link No. 1	WRF0E6	Word
Link No. 2	WRF146	Word

This register is incremented if there for example is a short circuit on the bus cable.

6.2.7 Number of rejected Profibus telegrams

Table 6.17 Number of rejected Profibus telegrams

Link module	Link address	Notes
Link No. 1	WRF0E7	Word
Link No. 2	WRF147	Word

6.2.8 Slave Config

Table 6.18 Slave config

Link module	Link address	Notes
Link No. 1	WRF0EC – WRF0F3	Bit-field
Link No. 2	WRF14C – WRF153	Bit-field

This 16 bytes bit-field indicates if a node is configured in the master or not. Address WRF0EC/WRF14C bit 0 corresponds to node address 0, bit 1 corresponds to node address 1 and so on. If the bit is 1, the corresponding node is configured, otherwise the node is not configured.

6.2.9 Slave State

Table 6.19 Slave state

Link module	Link address	Notes
Link No. 1	WRF0F4 – WRF0FB	Bit-field
Link No. 2	WRF154 – WRF15B	Bit-field

This 16 bytes bit-field indicates if a node is active in the data exchange or not. Address WRF0F5/WRF154 bit 0 corresponds to node address 0, bit 1 corresponds to node address 1 and so on. If the bit is 1, the corresponding node is active in the data exchange, otherwise the node is not active.

6.2.10 Device error

Table 6.20 Device error

Link module	Link address	Notes
Link No. 1	WRF107	High byte (Low byte not used)
Link No. 2	WRF167	High byte (Low byte not used)

Indicates internal faults in the Profibus DP master according to the table below.

Table 6.21 Detail of device error

Value	Name	Description
hex00	-	No error
hex0E	-	OS module, Firmware download
hex32	RAM_TEST	RAM check did not pass
hex35	FLASH_TEST	FLASH PROM checksum not ok
hex64 - hex6B	SYSTEM	Internal system error
hexC8	Unknown_IRQ	Unknown interrupt received, e.g. through system crash
hexC9	Watchdog	Internal watchdog expired
hexCA	TX_IRQ	Unexpected transmit interrupt from serial channel
hexCB	RX_IRQ	Unexpected receive interrupt from serial channel
hexFC	Download active	Firmware Download or Database Download active
hexFD	Bootloader active	Bootstrap loader active, firmware not running

Chapter 7 Daily and Periodic Inspection

In order to use the EH-RMP functions in the most desirable condition and maintain the system to operate normally, it is essential to conduct daily and periodic inspections.

(1) Daily inspection

Verify the following items while the system is running.

Table 7.1 Items for daily inspection

Item	LED display	Inspection method	Normal status	Main cause of error
EH-RMP indication	STATUS	Visual check	Lit Green	When unlit: Power supply error or Hardware error of EH-RMP. When lit Red: Hardware error of EH-RMP When flashing Green: Wrong setting value. When flashing Red: Hardware error of EH-RMP
	RDY	Visual check	Lit Green	When unlit: Power supply error or Hardware error of EH-RMP. When flashing: Hardware or system error
	RUN	Visual check	Lit Green or Flashing 4Hz	When unlit: Power supply error or Hardware error of EH-RMP. When random flashing: configuration error or fatal Error
	ERR	Visual check	Unlit	When lit Red: error on communication line
	TOKEN	Visual check	Lit Green	When unlit: Power supply error or Hardware error of EH-RMP

(2) Periodic inspection

Turn off the power for the external I/O ladder and check the following items once every six months.

Table 7.2 Items for periodic inspection

Part	Item	Check criteria	Remarks
Programming device to CPU	Check operation of programming device	All switches and display lamps work normally.	
Power supply	Check for voltage fluctuations	85 to 264 V AC (when EH-PSA) 21.6 to 26.4 V DC (when EH-PSD)	Tester
Installation and connecting areas	(1) All modules are securely fixed (2) All connectors fit snugly (3) All screws are tight (4) All cables are normal	No defects	Tighten Check insertion Tighten Visual check
Ambient environment	(1) Temperature (2) Humidity (3) Other	0 to 55 °C 20 to 90 % RH (no condensation) No dust, foreign matter, vibration	Visual check
Spare parts	Check number of parts, storage condition	No defects	Visual check
Program	Check program contents	Compare the contents of the latest program saved and CPU contents, and make sure they are the same	Check both master and backup.

Chapter 8 Troubleshooting

Trouble	Possible cause	Action
The ERR LED is lit even if the communication seems to work fine.	All nodes that are configured in the master are not present on the network.	Connect all nodes to make the ERROR LED turn off. Communication is running on nodes that are present in the network even if the ERROR LED is lit.
A slave does not get on-line even if the slave is configured in the master.	Node address in configurator does not match the actual node address.	Check the node address on the slave.
A slave does not react on a command from the PLC even if everything is configured correctly.	Wrong offset address is used in the PLC program for the specific slave.	Check the input and output offset addresses in the configurator to make sure that the right address is used.